

PART No. CWTF8

for more information visit

www.hammfg.com

Data subject to change without notice

Isometric drawing Not to Scale

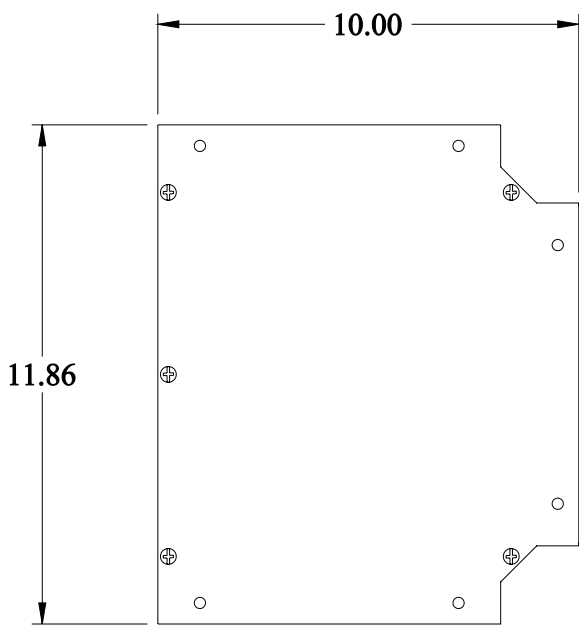

TOP VIEW

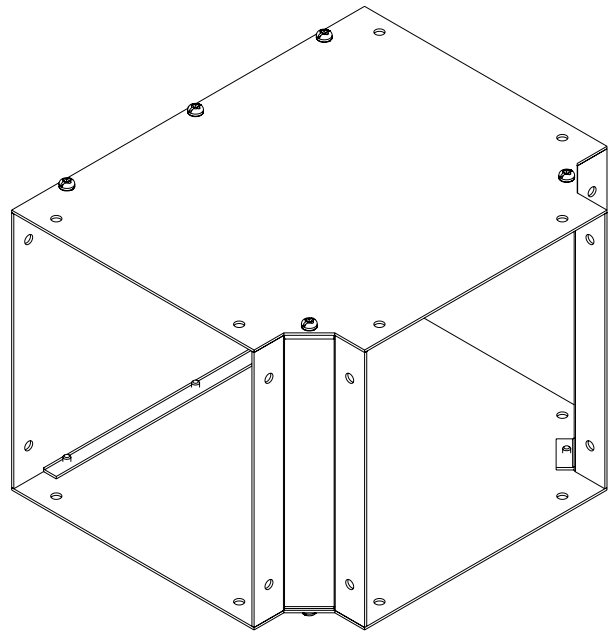

ISOMETRIC VIEW

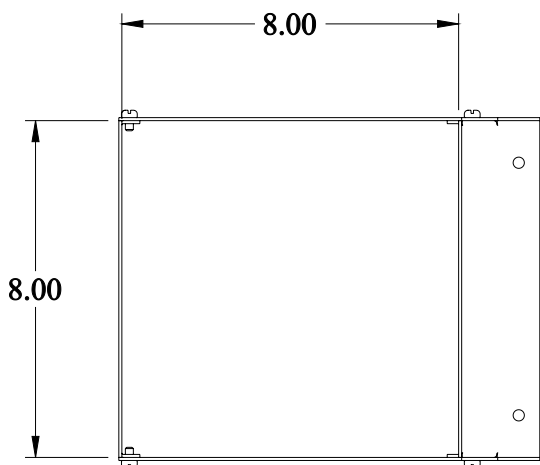

FRONT VIEW

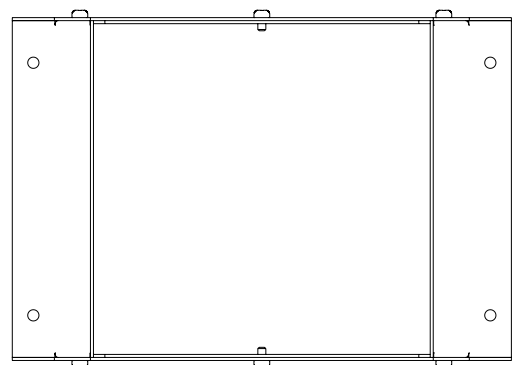

SIDE VIEW